

SINGLE COMPARATOR

■ GENERAL DESCRIPTION

The NJM2406 is a single comparator of ultra miniature surface mount package.

The NJM2406 is suitable for small electronic equipments and hybrid circuits.

■ PACKAGE OUTLINE

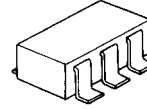

NJM2406F



NNJM2406F3

■ FEATURES

- Operating Voltage (2.5V~7V)
- Single Supply Operation
- Mounted in Ultra Miniature Package 2.0x1.25mm (1/8 of DMP8 package)
- Ground Shield Plate between +Input and Output
- Ground Shield Plate between +Input and -Input
- Suitable Pin Arrangement for Application
- Package Outline MTP5,SC88A
- Bipolar Technology

■ PIN CONFIGURATION

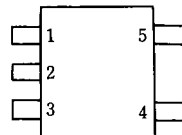

NJM2406F
NJM2406F3

PIN FUNCTION

1. -INPUT
2. GND
3. +INPUT
4. OUTPUT
5. V⁺

■ EQUIVALENT CIRCUIT

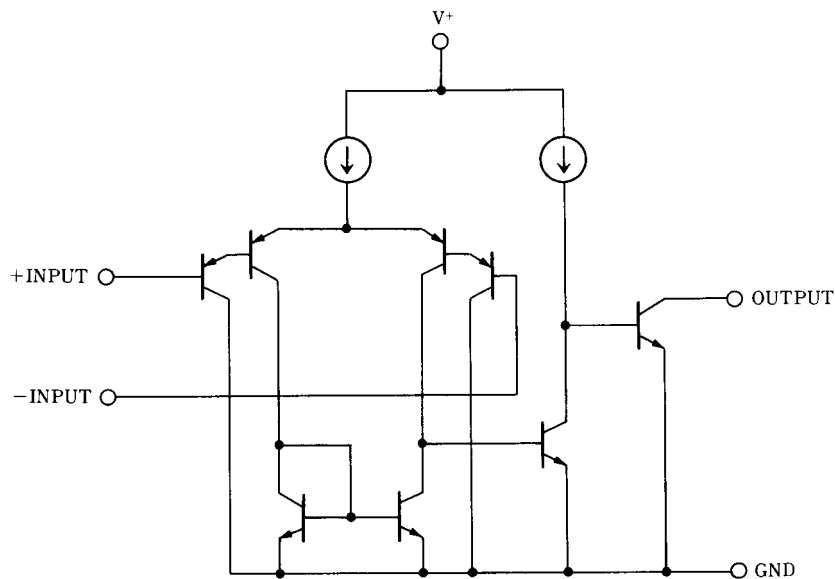

NJM2406

■ ABSOLUTE MAXIMUM RATINGS

(Ta=25°C)

PARAMETER	SYMBOL	RATINGS	UNIT
Supply Voltage	V^+	7	V
Differential Input Voltage	V_{ID}	7	V
Input Voltage	V_{IN}	-0.3~7	V
Power Dissipation	P_D	(MTP5) 200 (SC88A) 250 (note1)	mW
Output to Negative Supply Voltage	V_{SUS}	20	V
Operating Temperature Range	T_{opr}	-40~+85	°C
Storage Temperature Range	T_{stg}	-40~+125	°C

(note1) On glass epoxy board. (50x50x1.6mm)

■ ELECTRICAL CHARACTERISTICS

($V^+=5V, Ta=25°C$)

PARAMETER	SYMBOL	TEST CONDITION	MIN.	TYP.	MAX.	UNIT
Input Offset Voltage	V_{IO}	$R_S=0\Omega, V_O=1.4V$	-	1	7	mV
Input Offset Current	I_{IO}		-	1	50	nA
Input Bias Current	I_B		-	20	250	nA
Input Common Mode Voltage Range	V_{ICM}		0~3.5	-	-	V
Large Signal Voltage Gain	A_V	$R_L=15k\Omega$	-	106	-	dB
Response Time	t_R	$R_L=5.1k\Omega$	-	1.5	-	μs
Output Sink Current	I_{SINK}	$V_{IN}^- = 1V, V_{IN}^+ = 0V, V_O = 1.5V$	6	-	-	mA
Output Saturation Voltage	V_{SAT}	$V_{IN}^- = 1V, V_{IN}^+ = 0V, I_{SINK} = 5mA$	-	300	500	mV
Output Leakage Current	I_{LEAK}	$V_{IN}^- = 0V, V_{IN}^+ = 1V, V_O = 20V$	-	-	1	μA
Operating Current	I_{CC}		200	400	800	μA

■ TYPICAL CHARACTERISTICS

Input Bias Current vs. Temperature

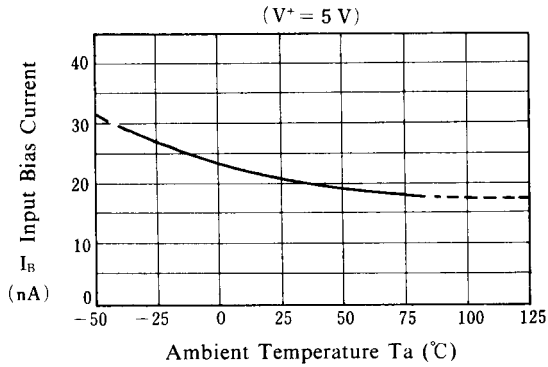

Input Offset Voltage vs. Temperature

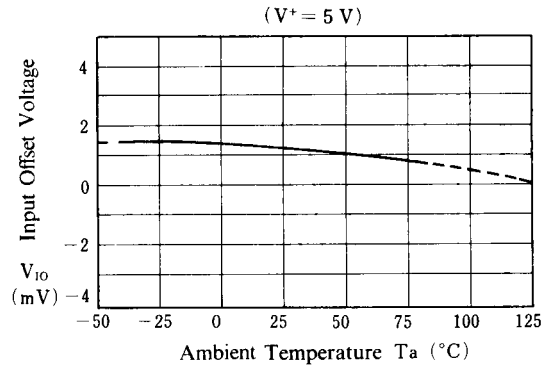

Operating Current vs. Operating Voltage

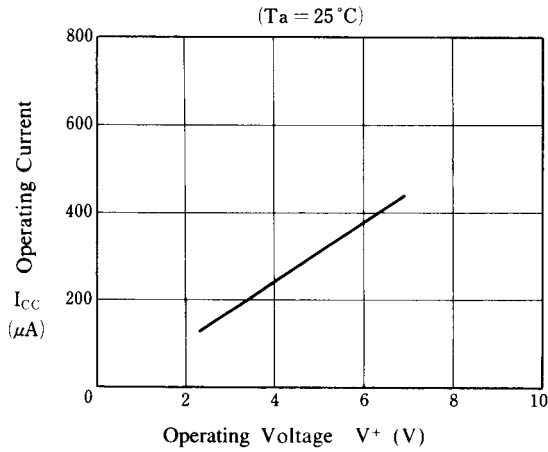

Input Bias Current vs. Operating Voltage

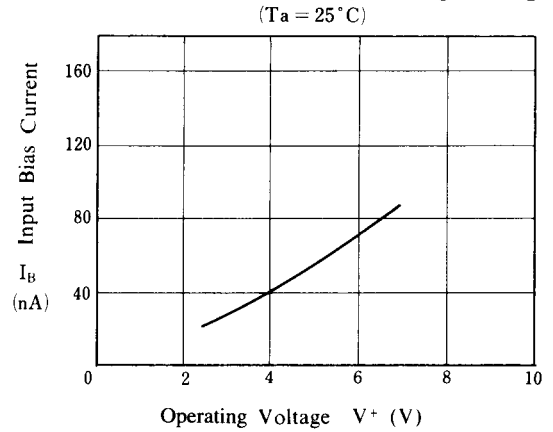

Output Saturation Voltage vs. Output Sink Current

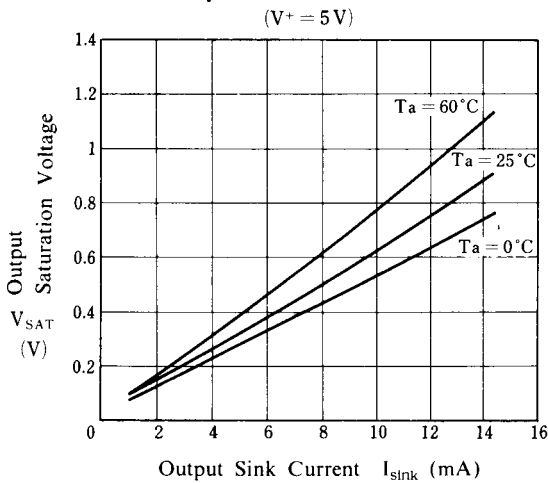

Output Saturation Voltage vs. Operating Voltage

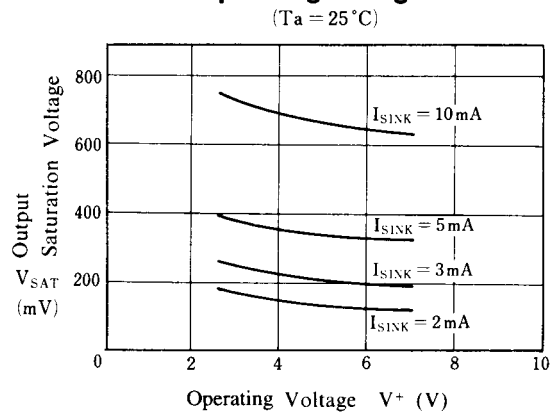

■ TYPICAL CHARACTERISTICS

Response Time for Various Input Over Drives

($T_a = 25^\circ\text{C}$)

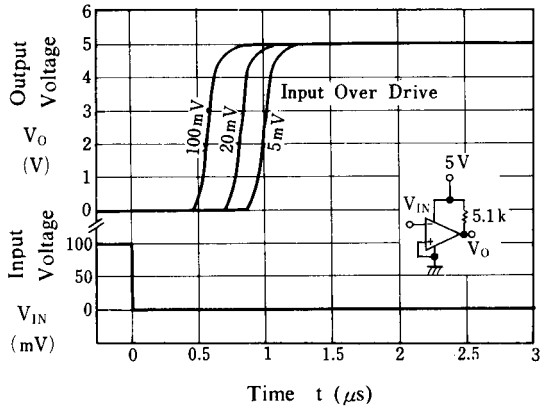

Response Time for Various Input Over Drives

($T_a = 25^\circ\text{C}$)

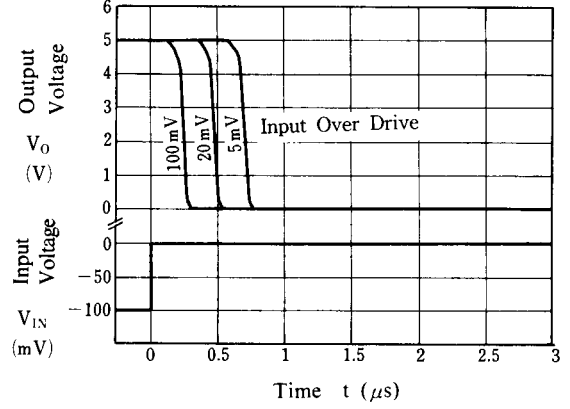

[CAUTION]

The specifications on this databook are only given for information, without any guarantee as regards either mistakes or omissions. The application circuits in this databook are described only to show representative usages of the product and not intended for the guarantee or permission of any right including the industrial rights.